

Practice Worksheet 13-4

Surface Area of Prisms

Find the surface area of each prism.

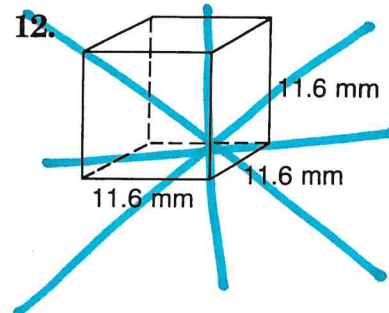
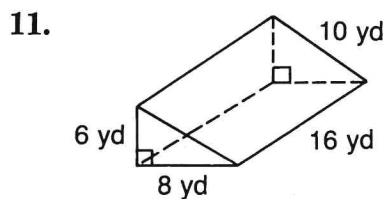
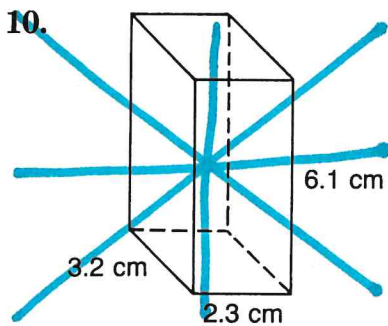
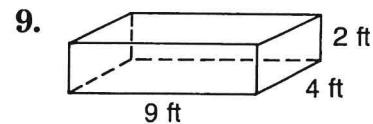
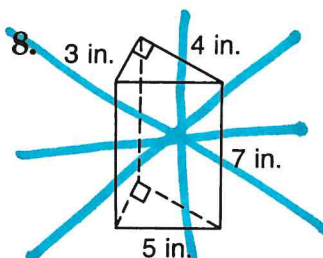
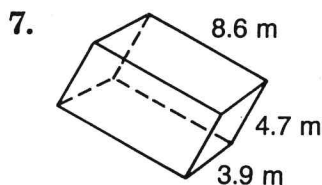
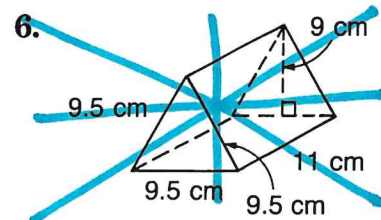
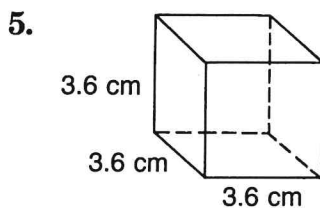
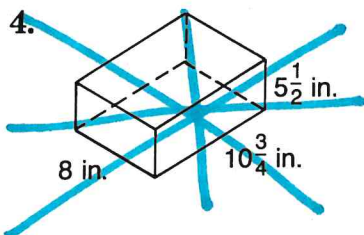
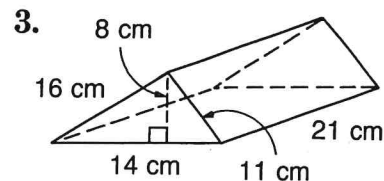
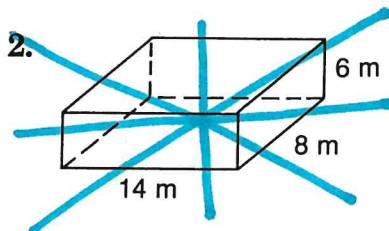
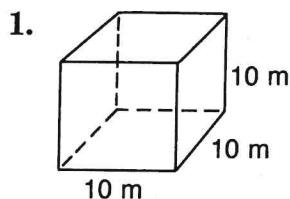

Practice Worksheet 13-5

Surface Area of Cylinders

Find the surface area of each cylinder.

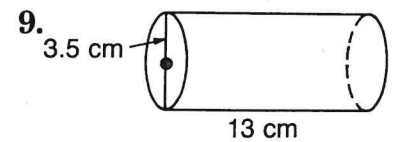
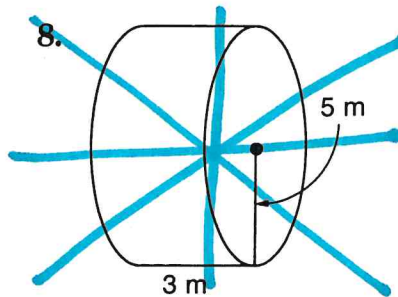
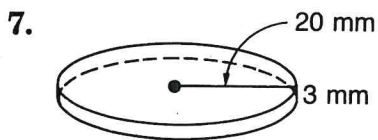
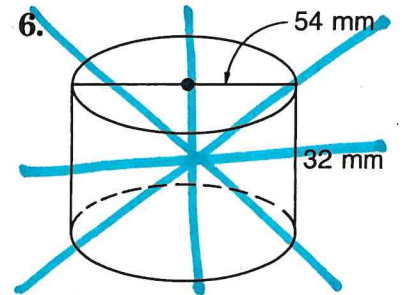
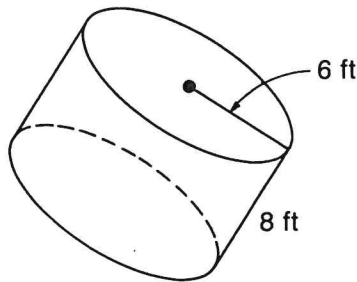
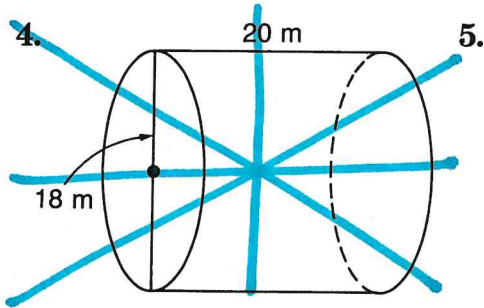
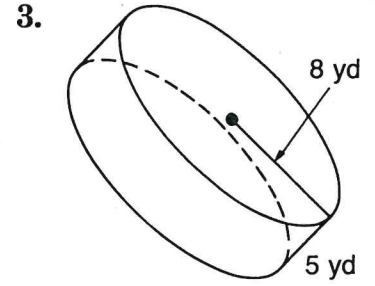
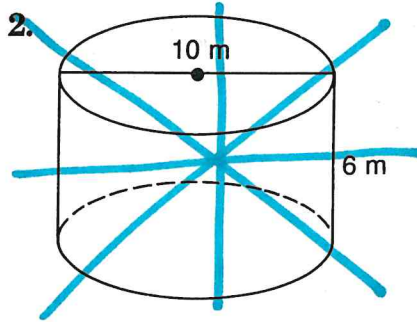
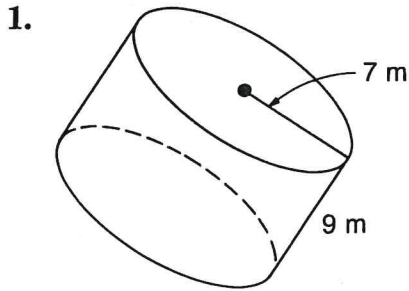

Practice Worksheet 13-6

Surface Area of Pyramids and Cones

Find the surface area of each pyramid or cone.

